

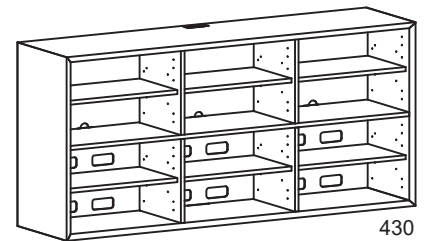

clic Wall bracket 3

Version 2.0

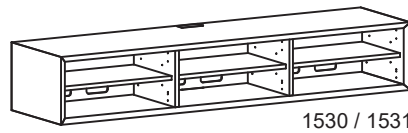
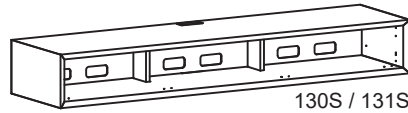
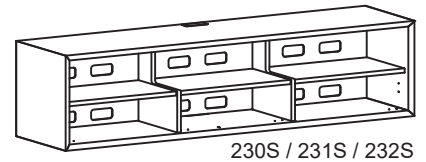
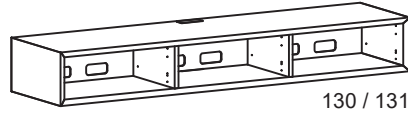
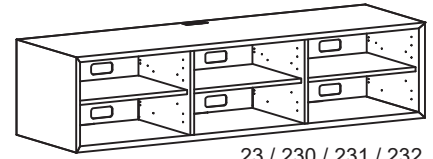
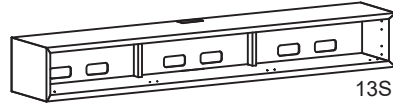

Beslag inkluderet
Fittings included
 Beschläge inbegriffen

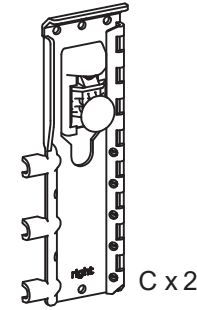
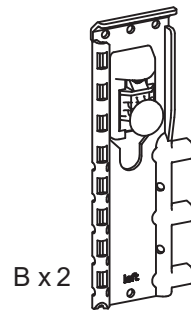
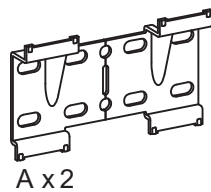

Nødvendige beslag
 (Ikke inkluderet)
Fittings needed
 (Not included)
 Geeignetes Montage-
 material (Nicht im Liefere-
 rumfang enthalten)



Skruer og rawlplugs afhænger af vægtype, spørg en fagmand.
Screws and plugs depends on the type of wall, ask a professional.
 Schrauben und Dübel müssen den baulichen Voraussetzungen angepasst
 werden. Fragen Sie einen Fachmann.

Nødvendigt værktøj
Tools needed
 Benötigte Werkzeuge

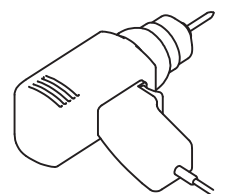
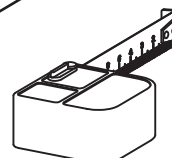
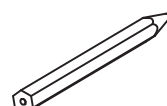
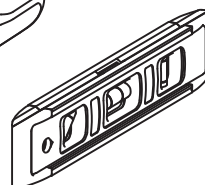
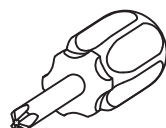

Wall Bracket 3

Maksimal belastning
 Maximum Load
 Maximale Belastung

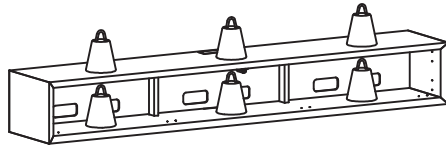

clic 13S = 50kg

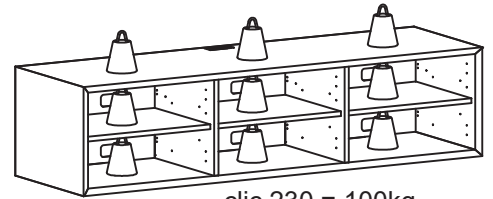

clic 230 = 100kg
 clic 231 = 100kg
 clic 232 = 100kg

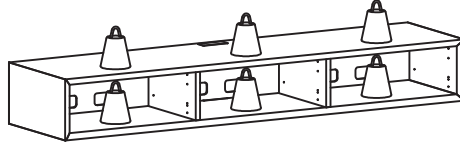

clic 130 = 50kg
 clic 131 = 40kg

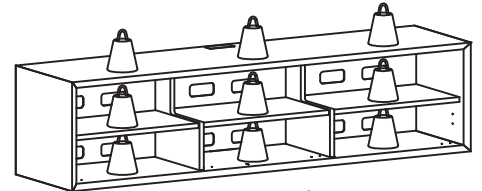

clic 230S = 70kg
 clic 231S = 70kg
 clic 232S = 70kg

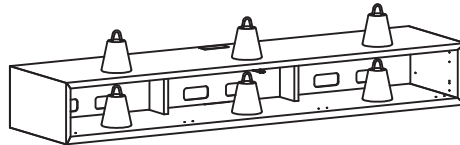

clic 130S = 50kg
 clic 131S = 40kg

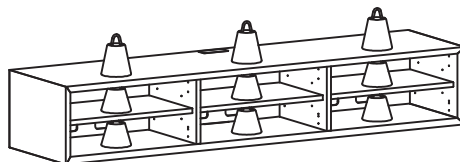

clic 1530 = 80kg
 clic 1531 = 80kg

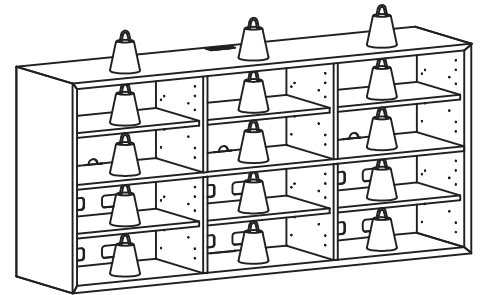

clic 430 = 100kg

1

1.1

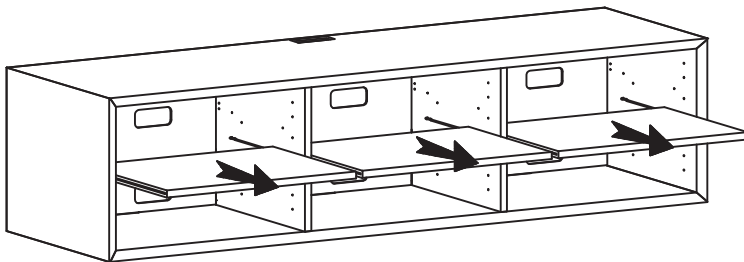

1.2

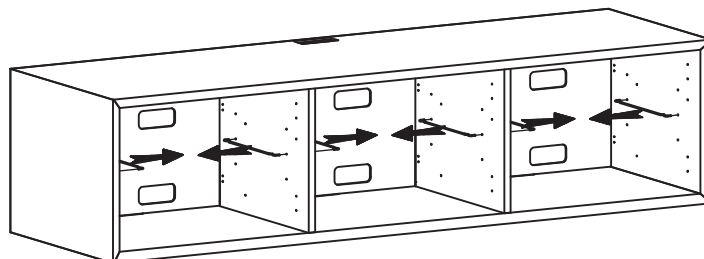

1.3

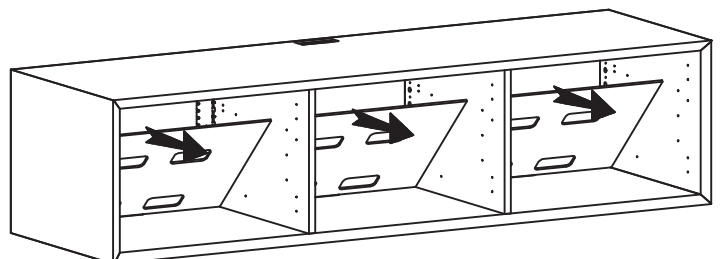

2

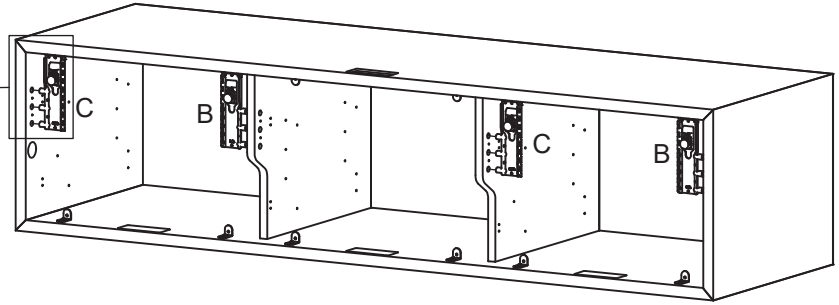
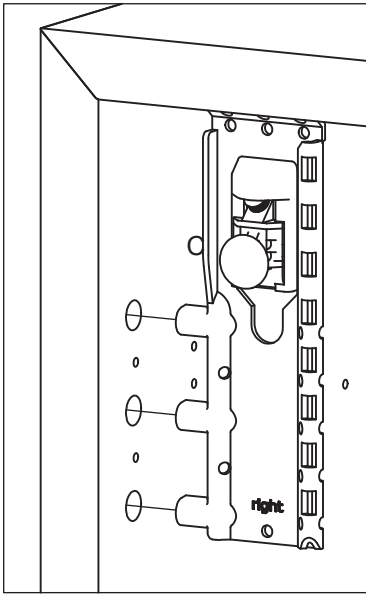

3

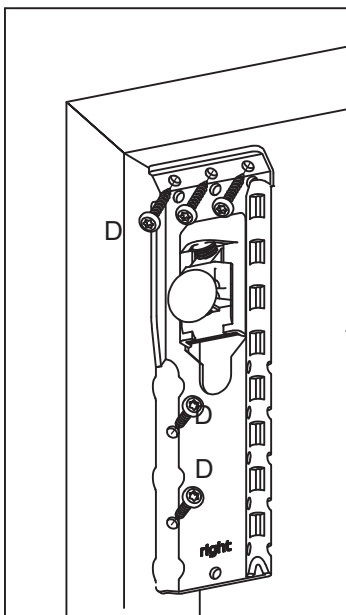

Pas på ikke at overspænde skruerne.
Be careful not to over-tighten the screws.
 Achten Sie darauf, die Schrauben nicht zu stark anzuziehen.

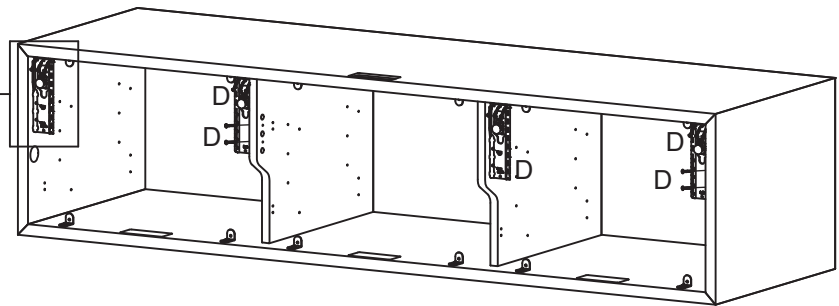

4

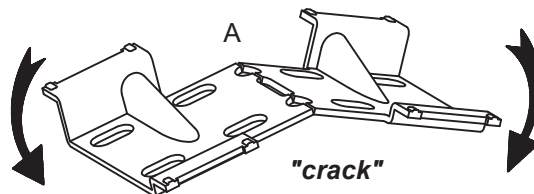

5

5A

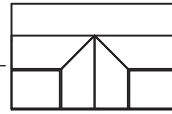
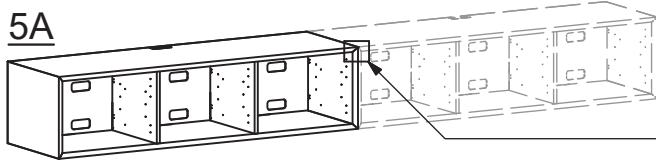

5B

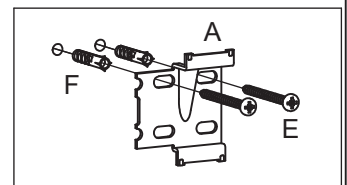
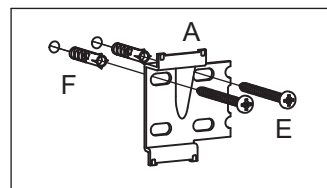
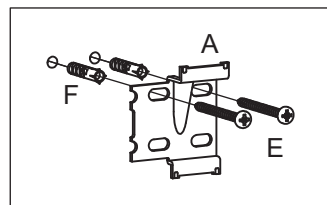
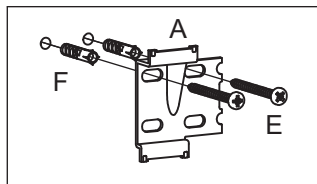
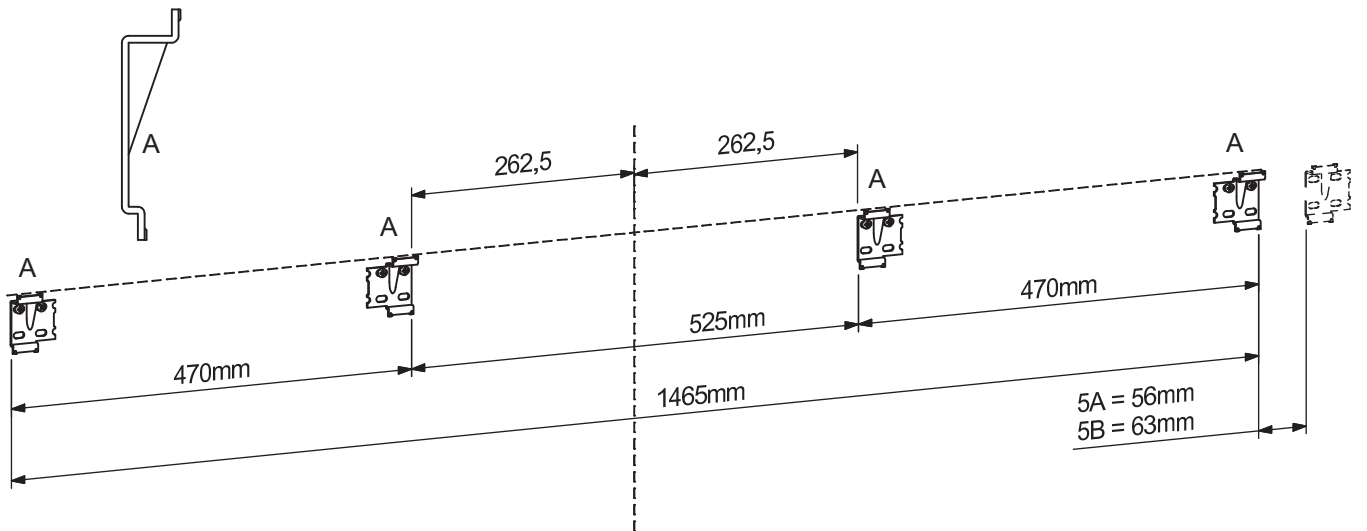
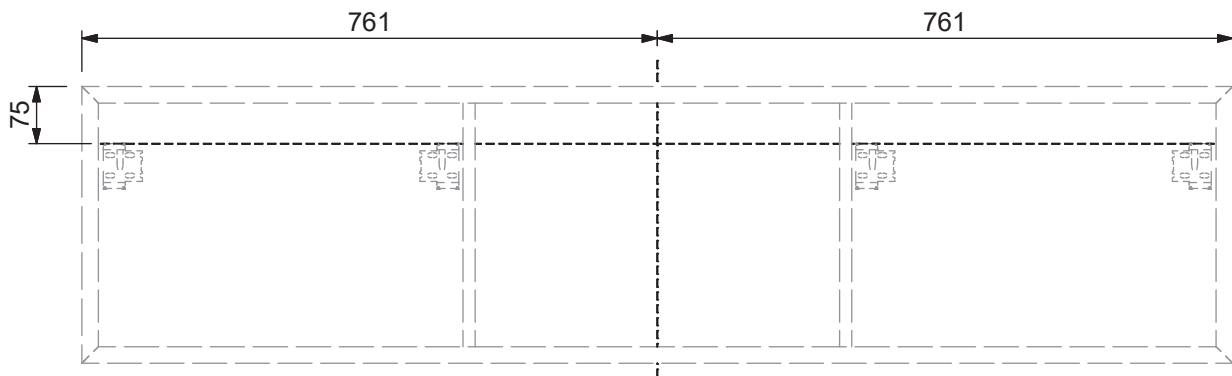
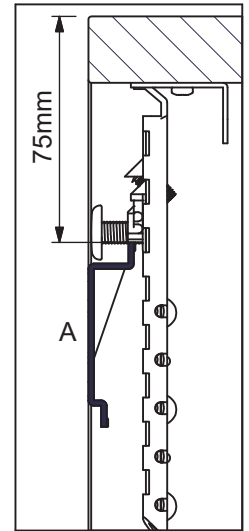
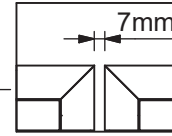
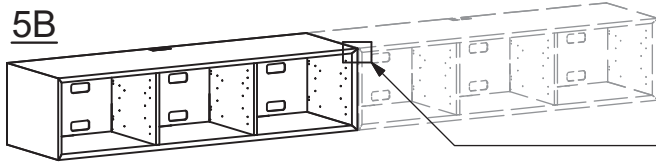

Wall Bracket 3

